

LEAST MATERIAL CONDITION

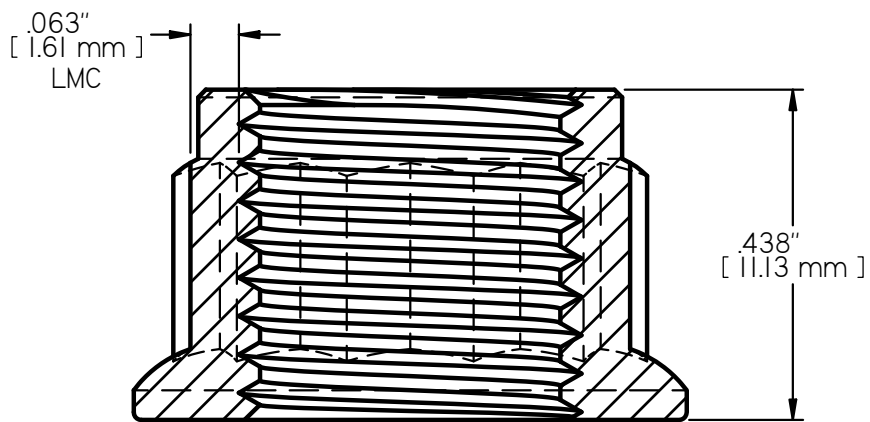
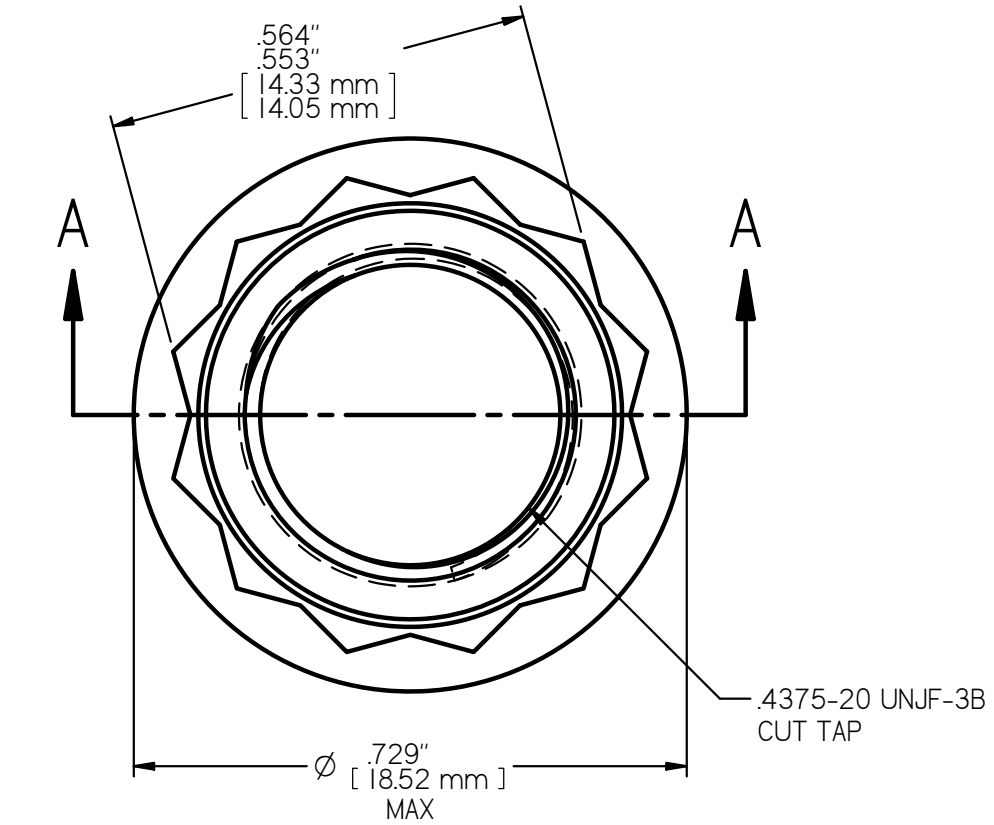

SECTION A-A
4X SCALE

NAS1804-7 LOCK NUT
AXIAL STRENGTH: 23,200 LBS. [103,199 N.] MIN