

# LEAST MATERIAL CONDITION

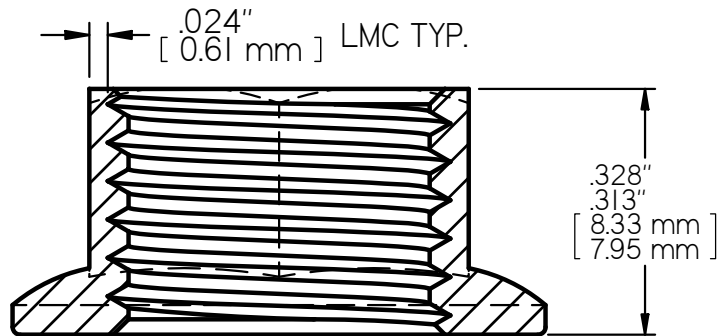
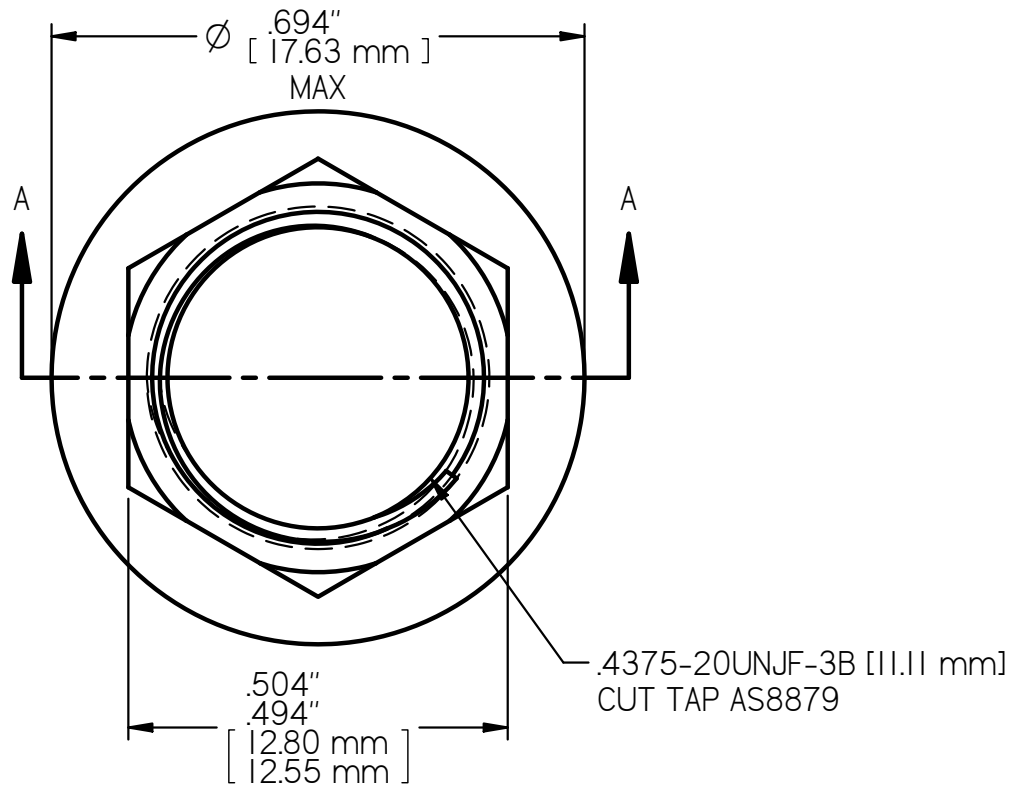

SECTION A-A  
4X SCALE

**NAS1291-7 LOCK NUT**  
**AXIAL STRENGTH: 20,600 LBS. [91,633 N.] MIN**